

N.B. - Min. Elev. 2.0M ABOVE F.S.L.

17No. Pales PER PANEL
ALL PALES FULL Y WELDED TO HORIZONTAL ANGLE

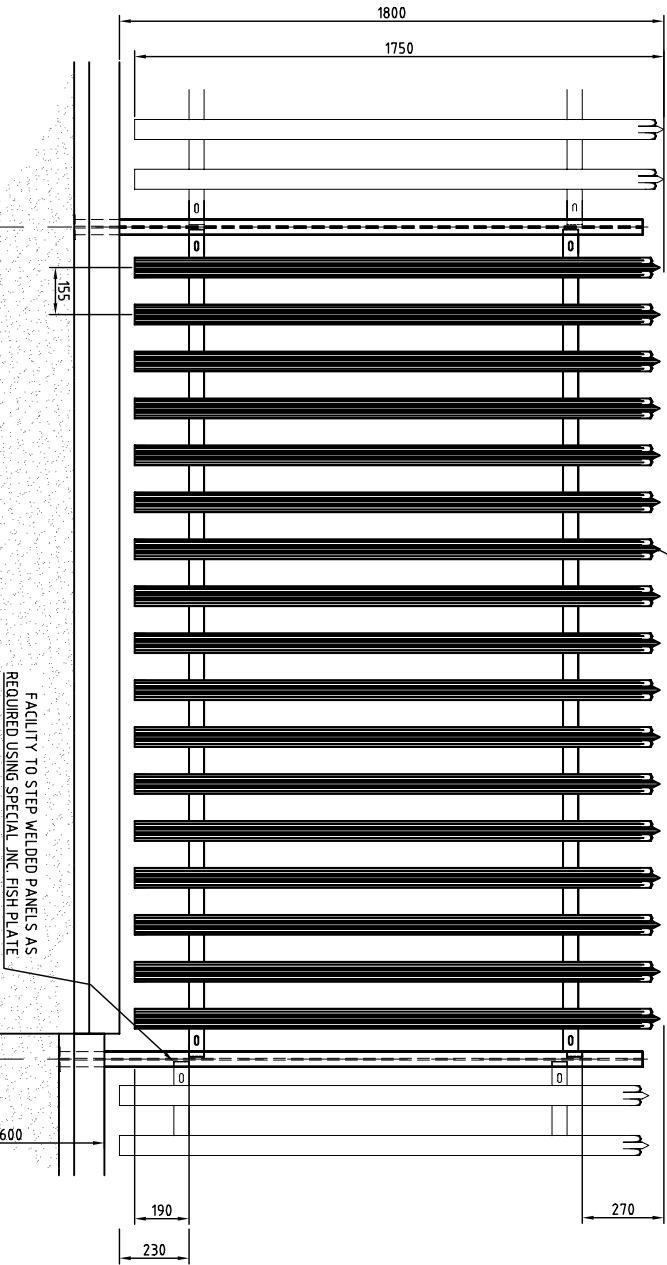

FRONT ELEVATION
scale 1/25

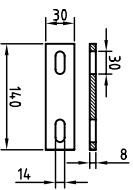

FISHPLATE

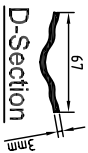

D-Section

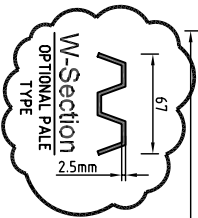

W-Section
OPTIONAL PALE TYPE

PLAN
scale 1/25

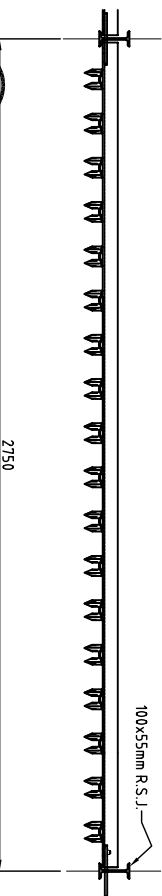

SIDE VIEW
scale 1/25

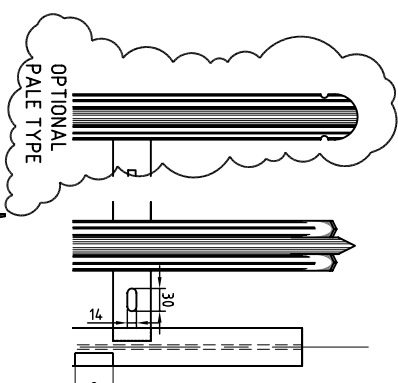

OPTIONAL PALE TYPE

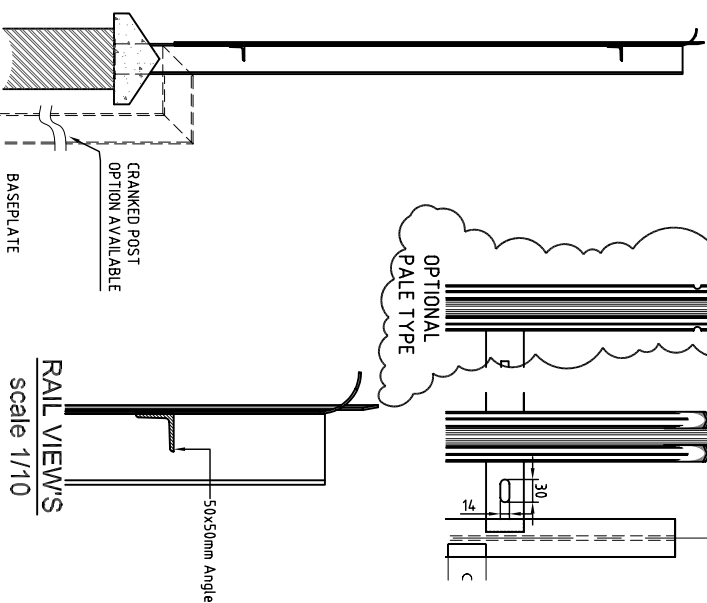

RAIL VIEWS
scale 1/10

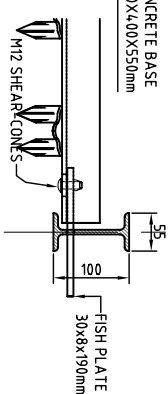

PANEL TO POST
scale 1/10

Drawing Title:	Typical JNC Pal Fence : H - 1.8M FOR INFORMATION ONLY
Project / Client:	SAMPLE DRAWING
Drawing/Doc.No:	JNC/GP/MW/18
Date:	04/11/02
By:	D.D.S.
App:	JNC FENCING



J.N.CUMMINS & Co.LTD
Industrial Fencing Contractors
Supply / Supply and Erection
Mayfield, Cashel, Co Tipperary
Tel: 00353 62 62214 Fax: 00353 62 62947
e-Mail: info@jncfencing.com
www.jncfencing.com